

JMA®



CATÁLOGO CARCASAS
KEY SHELLS CATALOGUE

CKS.06



www.jma.es

A5 **JMA es Compromiso**
JMA Konpromisoa da
JMA is Commitment
JMA, l'engagement
JMA bedeutet Verpflichtung

A6 **ADVERTENCIA LEGAL**
Lege-abisua
Legal warning
Texte Legal
Rechtlicher Hinweis
Advertência legal
Nota prawna

A7 **SIMBOLOGÍA**
Sinbologia
Symbols
Symbologie
Symbole
Simbologia legal
Symbolika

A8-A10 **ÍNDICE**
Aurkibidea
Index
Index
Hauptmarke
Indice
Spis marek

1 - 77 **LLAVES**
GILTZAK
KEYS
CLES
SCHLÜSSEL
CHAVES
KLUCZE

2
3- 4
5 - 7
7 - 9
9- 12
12 - 20
20
20 - 21
21 - 27
27 - 29
29- 32
32 - 35
35
35
36-37
37
37- 39
39 - 40
40 - 42
42 - 43
43 - 45
45 - 46
46 - 50
50 - 58
59 - 63
64
64
65
66
67 - 68
68
68 - 70
70 - 71
71 - 75
75 - 77

ALFA ROMEO
AUDI
BMW
CHEVROLET
CHRYSLER
CITROEN
COBRA
DACIA
FIAT
FORD
HONDA
HYUNDAI
ISUZU
IVECO
LANCIA
LAND RANGE ROVER
LEXUS
MAZDA
MERCEDES
MINI
MITSUBISHI
NISSAN
OPEL
PEUGEOT
RENAULT
ROVER
SAAB
SEAT
SKODA
SMART
SSANGYONG
SUBARU
SUZUKI
TOYOTA
VOLKSWAGEN

79 -84 **OTROS**
BESTE BATZUK
OTHERS
AUTRES
ANDERE
OUTRAS
INNE

80 - 81 **ESPADINES**
EZPATA
BLADES
LAMES
ZUNGE
LAMINA
GROTY

82 - 83 **TL**
TL
HORSESHOES
INSERTS
TL
TL
TL

84 **ACCESORIOS**
OSAGARRIAK
ACCESSORIES
ACCESSOIRES
ZUBEHÖRTEILE
ACESSORIOS
AKCESORIA

NUESTRO ÉXITO ESTÁ BASADO EN EL COMPROMISO DE LAS PERSONAS

OUR SUCCESS IS BASED ON OUR PEOPLE'S COMMITMENT

JMA Alejandro Altuna S.L.U. es la sociedad matriz e impulsora de Altuna Group. Fabrica todo tipo de llaves para cerradura así como máquinas duplicadoras. Sus productos van destinados al mercado OEM y a la reposición, en este caso con la marca JMA.

Fundada por el Sr. Alejandro Altuna en 1942 arrancó su actividad en Mondragón. Posteriormente, la estrategia de apertura de mercados exteriores apoyada en la internacionalización y siempre basada en un enfoque innovador de los procesos industriales, ha convertido a ALTUNA GROUP en el primer productor de llaves europeo y referente mundial en este campo.

Actualmente, 15 compañías en 4 continentes trabajan conjuntamente para el desarrollo y potenciación de la fuerza de nuestra marca JMA, conocida en más de 100 países en todo el mundo.

JMA integra equipos de personas comprometidas y motivadas por un proyecto común que nos ha permitido ser el mayor fabricante de llaves de Europa.

JMA Alejandro Altuna S.L.U. is the parent company and driving force behind the Altuna Group. It manufactures all types of lock-keys and key-cutting machines. Its products are for the OEM and replacement markets, in the latter case with the JMA brand.

Set up by Alejandro Altuna in 1942, it started the production in Mondragón (Spain). Later, the strategy of opening up to foreign markets backed by globalisation and always based on an innovative attitude towards industrial processes, turned the ALTUNA GROUP into the largest producer of keys in Europe and a benchmark worldwide in the field.

Currently 15 companies in four continents work together to develop the strength of our JMA brand, well known in more than 100 countries all over the world.

This successful trail that led us to be the biggest key producer in Europe is based in our people's commitment to be:

LÍDER EN TECNOLOGÍA:

Una apuesta sólida por la calidad y la innovación basada en la automatización y garantía de procesos y soportada por una vocación inversora a largo plazo.



THE LEADER IN TECHNOLOGY,

looking for the latest developments to improve the production processes together with a strong investment policy in all our plants to ensure the company's competitiveness and long-term future.

LÍDER EN CALIDAD:

Nuestra política de calidad se basa en la prevención y planificación, mejora continua, satisfacción del cliente y participación de las personas. Además de la Certificación en Calidad de acuerdo a la ISO 9001, Alejandro Altuna S.A. acoge Sistemas de Gestión de la Calidad homologados por las empresas líderes del sector de automoción y residencial.



THE LEADER IN QUALITY:

Our quality policy is based on prevention and planning, continuous improvement, customer satisfaction and people participation. In addition to Quality Certification to ISO 9001, Alejandro Altuna S.A. operates Quality Management Systems approved by the leading companies in the automotive and residential sectors.

LÍDER EN EL COMPROMISO POR EL MEDIO AMBIENTE:

En JMA Alejandro Altuna S.L.U. las buenas prácticas medioambientales son la norma y no la excepción. Nuestro equipo forma parte de un proyecto de empresa respetuoso con el medioambiente y que colabora con el desarrollo sostenible de nuestro entorno. JMA Alejandro Altuna S.L.U. fue el primer fabricante mundial de llaves en conseguir en 2000 el certificado ISO 14001 para su Sistema de Gestión.



THE LEADER IN THE COMMITMENT TO THE ENVIRONMENT:

At JMA Alejandro Altuna S.L.U. best environmental practice is the norm and not the exception. Our team is part of a business project that respects the environment and contributes to the sustainable development of our community. JMA Alejandro Altuna S.L.U. was the first key manufacturer in the world to achieve ISO 14001 certification for its management system in 2000.

LÍDER EN SERVICIO:

La realidad de una empresa se demuestra en su capacidad por responder con la máxima celeridad y eficacia a las necesidades y exigencias de los clientes. Se encuentren donde se encuentren. Además, gracias a su amplia red de filiales y empresas distribuidoras repartidas por todo el mundo, le permite llegar a cualquier cliente, se cual sea su ubicación.



THE LEADER IN SERVICE,

The efficiency of a company is shown in its capacity to respond with the maximum speed and effectiveness to the needs and requirements of its customers, wherever they are based. Moreover, with its extensive network of associate and distribution companies located throughout the world, the company can reach any customer, wherever based.

ESPAÑOL

Conforme a las disposiciones legales vigentes relativas a la propiedad industrial, las marcas o nombres comerciales indicados en este catálogo son propiedad exclusiva de los fabricantes de cilindros y cerraduras, así como de los fabricantes de automóviles. Dichas marcas o nombres comerciales se indican en calidad simplemente informativa con el fin de reconocer con rapidez la cerradura a la que corresponden nuestras piezas.

Este catálogo está reservado exclusivamente a profesionales de la reproducción de llaves que utilizan piezas JMA. Los datos referentes a los productos de este catálogo tienen carácter indicativo. Manteniendo siempre las características básicas, nos reservamos el derecho de realizar, sin previo aviso, modificaciones técnicas, estéticas o de otro tipo, por razones de evolución de los productos en cuestión.

EUSKERA

Industria-jabegoari dagozkion indarrean dauden lege-xedapenekin bat etorri, katalogo honetan ageri diren marka edo merkataritza-izenak zilindro eta sarrailen fabrikatzaileen jabego eskusibokoak dira, eta baita ibilgailuen fabrikatzaileena. Aipatutako markak edo merkataritza-izenak modu informatiboan soilik aipatzen dira, gure piezak zein sarrailarekin doazen azkar jakin ahal izateko.

Katalogo hau JMA piezak erabiltzen dituzten giltzen bikoizketara dedikatzen diren profesionaleri zuzenduta dago. Katalogo honetako produktuei dagozkien datuak azalpen izaera dute. Beti, oinarriko ezaugarriak mantenduz, aurreko abisurik gabe, produktu horiek eboluzionatzen dutelako, aldaketa teknikoak, estetikoak edo beste motatakoan egiteko eskubidea dugu.

DEUTSCH

Gemäß den geltenden gesetzlichen Bestimmungen bezüglich des gewerblichen Eigentums, der Marken oder Handelsnamen, die in diesem Katalog angegeben sind, sind diese ausschließliches Eigentum der Hersteller der Zylinder und Schlösser sowie der Fahrzeughersteller. Diese Marken oder Handelsnamen werden aus rein informativen Gründen angegeben, um die Schlösser, zu denen unsere Teile gehören, schneller zu erkennen.

Dieser Katalog ist ausschließlich für Fachleute auf dem Gebiet der Reproduktion von Schlüsseln gedacht, die Teile von JMA verwenden. Die Daten bezüglich der Produkte dieses Katalogs haben indikativen Charakter. Unter Beibehaltung der grundlegenden Charakteristiken behalten wir uns das Recht vor, ohne Vorankündigung technische, ästhetische oder sonstige Modifikationen aufgrund der Weiterentwicklung der fraglichen Produkte vorzunehmen.

POLSKI

Zgodnie z aktualnymi przepisami prawnymi związanymi z ochroną własności przemysłowej, marki i nazwy handlowe wymienione w tym katalogu są wyłączną własnością producentów wkładek i zamków, oraz producentów samochodów. Zarówno marki jak i nazwy handlowe są wykorzystywane jedynie w celu szybkiego rozpoznania zamka, któremu odpowiadają nasze produkty. Ten katalog jest zarezerwowany wyłącznie dla profesjonalistów kopiowania kluczy korzystających z produktów JMA. Informacje odnoszące się do produktów w katalogu mają charakter orientacyjny. Przy zachowaniu podstawowych parametrów, zastrzegamy sobie prawo, bez uprzedniego powiadomienia, do zmian technicznych, estetycznych lub innych, w celu poprawy produktów.

ENGLISH

In accordance with current legal dispositions related to industrial property, the brands or commercial names indicated in this catalogue are the exclusive property of the manufacturers of cylinders and locks, as well as the manufacturers of automobiles. These brands or commercial names are used as mere information in order to quickly recognise the lock to which our parts correspond.

This catalogue is exclusively reserved to professional key duplicators that use JMA pieces. The data referring to the products of this catalogue is merely informative. Always maintaining the basic characteristics, we reserve the right to making, without previous notification, technical, aesthetic or other types of modifications, for improvement reasons of the products in question.

FRANÇAIS

Conformément aux dispositions légales en vigueur relatives à la propriété industrielle, les marques ou les dénominations commerciales citées dans ce catalogue sont la propriété exclusive des fabricants de cylindres et de serrures ainsi que des constructeurs de voitures, autres constructeurs, distributeurs et utilisateurs. Ces marques ou dénominations commerciales sont indiquées à titre de simple information afin de connaître rapidement à quelle serrure nos ébauches sont destinées.

Ce catalogue est exclusivement réservé aux professionnels de la reproduction de clés, utilisant des ébauches JMA. Les renseignements sur les produits de ce catalogue sont donnés à titre indicatif. Tout en gardant les caractéristiques de base, nous nous réservons le droit d'apporter, sans préavis, des modifications techniques, esthétiques ou autres, dues à l'évolution des produits en question.

POTUGUESE

Em conformidade com as disposições legais vigentes sobre a propriedade industrial, as marcas ou nomes comerciais indicados neste catálogo são propriedade exclusiva dos fabricantes de cilindros e fechaduras, assim como dos fabricantes de automóveis. Ditas marcas ou nomes comerciais mencionam-se com propósitos meramente informativos, com o fim de reconhecer com rapidez a fechadura a que correspondem as nossas peças.

Este catálogo está reservado exclusivamente a profissionais da reprodução de chaves que utilizam peças JMA. Os dados referentes aos produtos deste catálogo têm carácter meramente indicativo. Mantendo sempre as características básicas, reservamo-nos o direito de realizar, sem prévio aviso, quaisquer modificações técnicas, estéticas ou de outro tipo, resultantes da evolução dos produtos em questão.

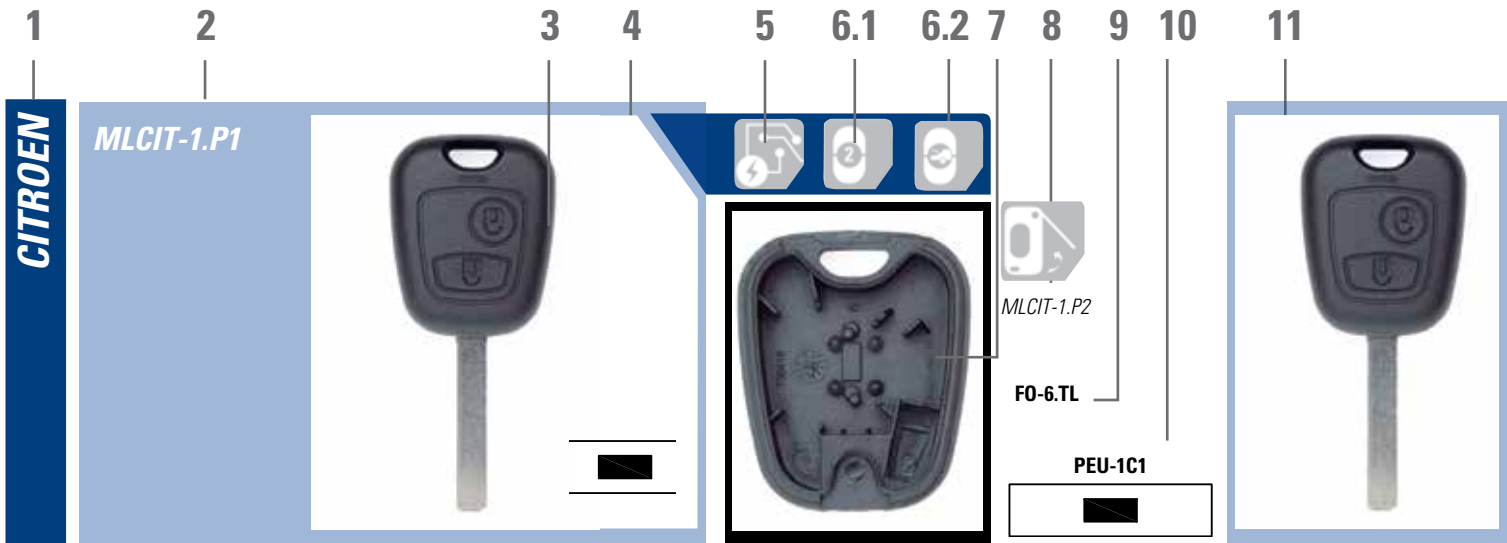

1. MARCA	3. IMAGEN JMA	5. DETALLES PILA	7. IMAGEN DETALLADA	9. COMPATIBLE LLAVE TL	11. LLAVE ORIGINAL
1. MARKA 1. BRAND 1. MARQUE 1. MARKE 1. MARCA 1. MARKA	3. JMA IRUDIA 3. IMAGE JMA 3. IMAGE JMA 3. BILD JMA 3. IMAGEM JMA 3. ZDJĘCIE JMA	5. PILAREN XEHETASUNAK 5. BATTERY DETAILS 5. DETAIL PILE 5. DETAILS BATT 5. DETALHES PILA 5. INFORMACJE O BATERII	7. IRUDI XEHEA 7. DETAILED IMAGE 7. IMAGE DE DETAIL 7. DETAILLIERTES BILD 7. IMAGEM DETALHADA 7. SZCZEGÓŁOWE ZDJĘCIE	9. TL GILTZA BATERGARRITASUNA 9. COMPATIBLE HORSESHOE 9. INSERT COMPATIBLE 9. KOMPATIBLER TL SCHLÜSSEL 9. COMPATIBILIDADE TL 9. KOMPATYBILNOŚĆ TL	11. JATORRIZKO GILTZA 11. ORIGINAL KEY 11. CLE ORIGINALE 11. ORIGINALSCHLÜSSEL 11. CHAVE ORIGINAL 11. KLUCZ ORYGINALNY
2. REF. JMA	4. PERFIL	6. BOTONES (1-NÚMERO/2-TIPO)	8. CONVERTIBILIDAD	10. ESPADIN JMA	
2. EREF. JMA 2. REF. JMA 2. REF. JMA 2. REF. JMA 2. REF. JMA 2. SYMBOL JMA	4. PERFILA 4. PROFILE 4. PROFIL 4. PROFIL 4. PROFIL	6. BOTOIAK (1-ZENBAKIA/2-MOTA) 6. BUTTONS (1-NUMBER/2-TYPE) 6. BOUTON(1-NUMERO/2-TYPE) 6. KNÖPFE (1-ANZAHL/2-TYP) 6. BOTÕES (1-NÚMERO/2-TIPO) 6. PRZYCISKI (1-IŁOŚĆ/2-TYP)	8. BIHURGARRITASUNA 8. CONVERTIBILITY 8. CONVERTIBLE 8. KONVERTIERBARKEIT 8. CONVERTIBILIDADE 8. ZAMIENNIK	10. JMA EZPATA 10. JMA BLADE 10. LAME JMA 10. ZUNGE JMA 10. LAMINA JMA 10. GROT JMA	

BOTONES/BUTTONS



PILA/BATTERY



ESCAMOTEABLE/FLIP KEY



ALFA ROMEO

MLAF01	2
MLFI-16.P4	2
MLFI-16.P5	2
MLFI-16.P9	2

AUDI

MLAU01	3
MLAU02	3
MLAU03	3
MLAU04	3
MLAU05	4
MLAU06	4
MLAU07	4
MLHU-HAA.P2	4

BMW

MLBM01	5
MLBM02	5
MLBM-5.P1	5
MLBM-5.P2	5
MLBM-5.P3	6
MLBM-6.P2	6
MLBM-6.P3	6
MLBM-6.P4	6
MLBM-6.P5	7
MLBM-9.P	7

CHEVROLET

MLDAE-3D.P6	7
MLGM01	7
MLGM-49D.P1	8
MLOP-11.P6	8
MLOP-11.P8	8
MLOP-WH.P1	8
MLOP-WH.P2	9
MLOP-WH.P3	9

CHRYSLER

MLCHR01	9
MLCHR02	9
MLCHR03	10
MLCHR04	10
MLCHR05	10
MLCHR06	10
MLCHR-15.P2	11
MLCHR-15.P3	11
MLCHR-15.P4	11
MLCHR-15.P5	11
MLCHR-15.P6	12

CITROEN

MLCIT01	12
MLCIT02	12
MLCIT03	12

MLCIT04	13
MLCIT05	13
MLCIT-1.P1	13
MLCIT-1.P2	13
MLCIT-1.P3	14
MLCIT-1.P11	14
MLCIT-1.P4	14
MLCIT-1.P5	14
MLCIT-1.P6	15
MLCIT-1.P7	15
MLCIT-1.P10	15
MLCIT-1.P14	15
MLHU-HCA.P1	16
MLHU-HCA.P2	16
MLHU-HCA.P3	16
MLHU-HCA.P9	16
MLHU-HCA.P4	17
MLHU-HCA.P5	17
MLHU-HCA.P6	17
MLHU-HCA.P7	17
MLHU-HCA.P10	18
MLHU-HCA.P11	18
MLNE-38.P5	18
MLNE-38.P6	18
MLSIX-3.P4	19
MLSIX-3.P5	19
MLSIX-3.P6	19
MLSIX-3.P7	19
MLSIX-3.P8	20

COBRA

MLHOND01	20
----------	----

DACIA

MLDAC-4D.P1	20
MLVA-34.P8	20
MLVA-34.P9	21

FIAT

MLFI01	21
MLFI02	21
MLFI03	21
MLFI04	22
MLFI05	22
MLFI06	22
MLFI07	22
MLFI08	23
MLFI09	23
MLFI10	23
MLFI11	23
MLFI12	24
MLFI-13.P9	24
MLFI-13.P10	24
MLFI-16.P2	24
MLFI-16.P3	25
MLFI-16.P6	25

MLFI-16.P7	25
MLFI-16.P8	25
MLFI-16.P10	26
MLFI-16.P11	26
MLFI-16.P12	26
MLFI-16.P13	26
MLFI-16.P14	27
MLHU-HCA.P1	27
MLHU-HCA.P2	27

FORD

MLF001	27
MLF002	28
MLF003	28
MLF004	28
MLFO-24.P1	28
MLFO-24.P3	29
MLFO-24.P4	29

HONDA

MLHOND02	29
MLHOND03	29
MLHOND-31.P1	30
MLHOND-31.P2	30
MLHOND-31.P3	30
MLHOND-31.P4	30
MLHOND-31.P5	31
MLHOND-31.P6	31
MLHOND-31.P7	31
MLHOND-31.P8	31
MLHOND-31.P9	32

HYUNDAI

MLHY01	32
MLHY02	32
MLHY03	32
MLHY-11.P5	33
MLHY-11D.P2	33
MLHY-11D.P6	33
MLHY-11D.P7	33
MLHY-18.P2	34
MLHY-18.P4	34
MLHY-18.P5	34
MLHY-18.P6	34
MLHY-18.P7	35
MLHY-18.P8	35

ISUZU

MLISU-3D.P3	35
-------------	----

IVECO

MLFI-13.P11	35
-------------	----

LANCIA

MLFI-13.P10	36
-------------	----

MLFI-16.P3	36
MLHU-HCA.P5	36
MLHU-HCA.P7	36
MLHU-HCA.P8	37

LAND RANGE ROVER

MLNE-52.P3	37
------------	----

LEXUS

MLTOYO01	37
MLHU-HCA.P1	37
MLHU-HCA.P2	38
MLTOYO-15.P3	38
MLTOYO-15.P5	38
MLTOYO-15.P6	38
MLTOYO-19.P2	39
MLTOYO-30.P2	39
MLTOYO-36.P1	39

MAZDA

MLMAZ-11D.P3	39
MLMAZ-21D.P2	40
MLMAZ-21D.P3	40

MERCEDES

MLME01	40
MLME02	40
MLME03	41
MLME-2.P1	41
MLME-2.P2	41
MLME-2.P3	41
MLME-7.P1	42
MLME-7.P2	42
MLME-7.P3	42

MINI

MLBM-8.P1	42
MLBM-8.P2	43
MLBM-8.P3	43
MLBM-8.P4	43

MITSUBISHI

MLMIT01	43
MLMIT02	44
MLHU-DH.P4	44
MLMIT-8D.P3	44
MLMIT-8D.P4	44
MLMIT-8D.P5	45
MLMIT-12.P3	45
MLMIT-12.P4	45

NISSAN

MLNS01	45
MLDAT-15.P6	46

ÍNDICE DE MARCAS

BRAND INDEX

MLDAT-15.P7	46
MLDAT-15.P8	46

OPEL

MLOP01	46
MLOP02	47
MLOP03	47
MLOP04	47
MLOP05	47
MLOP-11.P3	48
MLOP-11.P4	48
MLCIT-1.P8	48
MLCIT-1.P9	48
MLNE-38.P8	49
MLNE-38.P11	49
MLNE-38.P12	49
MLOP-11.P6	49
MLOP-11.P7	50

PEUGEOT

MLCIT01	50
MLCIT02	50
MLCIT03	50
MLCIT04	51
MLCIT-1.P1	51
MLCIT-1.P2	51
MLCIT-1.P3	51
MLCIT-1.P11	52
MLCIT-1.P4	52
MLCIT-1.P5	52
MLCIT-1.P6	52
MLCIT-1.P7	53
MLCIT-1.P10	53
MLFI01	53
MLFI02	53
MLFI-16.P7	54
MLHU-HCA.P1	54
MLHU-HCA.P2	54
MLHU-HCA.P3	54
MLHU-HCA.P9	55
MLHU-HCA.P4	55
MLHU-HCA.P5	55
MLHU-HCA.P6	55
MLHU-HCA.P7	56
MLHU-HCA.P8	56
MLNE-38.P5	56
MLNE-38.P6	56
MLNE-38.P15	57
MLNE-51.P3	57
MLNE-51.P4	57
MLNE-51.P5	57
MLNE-51.P6	58
MLSIX-3.P4	58
MLSIX-3.P5	58
MLSIX-3.P7	58

RENAULT

MLCIT-1.P1	59
MLCIT-1.P2	59
MLCIT-1.P8	59
MLCIT-1.P9	59
MLCIT-1.P12	60
MLCIT-1.P13	60
MLNE-38.P7	60
MLNE-38.P8	60
MLNE-38.P9	61
MLNE-38.P10	61
MLNE-38.P11	61
MLNE-38.P12	61
MLNE-38.P13	62
MLNE-38.P14	62
MLVA-34.P5	62
MLVA-34.P6	62
MLVA-34.P7	63
MLVA-34.P8	63
MLVA-34.P9	63
MLVA-34.P10	63

ROVER

MLRV01	64
MLBM-8.P3	64
MLNE-52.P4	64

SAAB

MLSAA-3.P2	64
------------	----

SEAT

MLV001	65
MLV002	65
MLV003	65
MLV004	65

SKODA

MLV001	66
MLV002	66
MLV003	66
MLV004	66

SMART

MLSMR01	67
MLSMR02	67
MLSMR03	67
MLME-HY.P1	67
MLME-HY.P2	68
MLSMR-1.P1	68

SSANGYONG

MLSSA-1.P2	68
------------	----

SUBARU

MLSUB-2.P1	68
MLSUB-2.P3	69
MLSUB-2.P4	69
MLSUB-3.P3	69
MLSUB-3.P4	69
MLISU-3D.P4	70

SUZUKI

MLSUZU01	70
MLSZ01	70
MLSUZU-14.P3	70
MLSUZU-14.P4	71
MLTOYO-15.P9	71

TOYOTA

MLTOYO01	71
MLTOYO02	71
MLKI-9.P1	72
MLCIT-1.P15	72
MLTOYO-15.P3	72
MLTOYO-15.P4	72
MLTOYO-15.P5	73
MLTOYO-15.P6	73
MLTOYO-15.P7	73
MLTOYO-19.P1	73
MLTOYO-19.P2	74
MLTOYO-19.P3	74
MLTOYO-20D.P2	74
MLTOYO-20D.P3	74
MLTOYO-30.P2	75
MLTOYO-36.P1	75
MLTOYO-43.P1	75

VOLKSWAGEN

MLV001	75
MLV002	76
MLV003	76
MLV004	76
MLHU-HAA.P3	76
MLHU-HAA.P4	77
MLHU-HAA.P5	77
MLHU-HAA.P6	77

REF	PAG
MLAF01	2
MLAU01	3
MLAU02	3
MLAU03	3
MLAU04	3
MLAU05	4
MLAU06	4
MLAU07	4
MLBM-5.P1	5
MLBM-5.P2	5
MLBM-5.P3	6
MLBM-6.P2	6
MLBM-6.P3	6
MLBM-6.P4	6
MLBM-6.P5	7
MLBM-8.P1	42
MLBM-8.P2	43
MLBM-8.P3	43 64
MLBM-8.P4	43
MLBM-9.P	7
MLBM01	5
MLBM02	5
MLCHR-15.P2	11
MLCHR-15.P3	11
MLCHR-15.P4	11
MLCHR-15.P5	11
MLCHR-15.P6	12
MLCHR01	9
MLCHR02	9
MLCHR03	10
MLCHR04	10
MLCHR05	10
MLCHR06	10
MLCIT-1.P1	13 51 59
MLCIT-1.P10	15 53
MLCIT-1.P11	14 52
MLCIT-1.P12	60
MLCIT-1.P13	60
MLCIT-1.P14	15
MLCIT-1.P15	72
MLCIT-1.P2	13 51 59
MLCIT-1.P3	14 51
MLCIT-1.P4	14 52
MLCIT-1.P5	14 52
MLCIT-1.P6	15 52
MLCIT-1.P7	15 53
MLCIT-1.P8	48 59
MLCIT-1.P9	48 59
MLCIT01	12 50
MLCIT02	12 50
MLCIT03	12 50
MLCIT04	13 51
MLCIT05	13
MLDAC-4D.P1	20
MLDAE-3D.P6	7
MLDAT-15.P6	46
MLDAT-15.P7	46
MLDAT-15.P8	46
MLFI-13.P10	24 36
MLFI-13.P11	35

REF	PAG
MLFI-13.P9	24
MLFI-16.P10	26
MLFI-16.P11	26
MLFI-16.P12	26
MLFI-16.P13	26
MLFI-16.P14	27
MLFI-16.P2	24
MLFI-16.P3	25 36
MLFI-16.P4	2
MLFI-16.P5	2
MLFI-16.P6	25
MLFI-16.P7	25 54
MLFI-16.P8	25
MLFI-16.P9	2
MLFI01	21 53
MLFI02	21 53
MLFI03	21
MLFI04	22
MLFI05	22
MLFI06	22
MLFI07	22
MLFI08	23
MLFI09	23
MLFI10	23
MLFI11	23
MLFI12	24
MLFO-24.P1	28
MLFO-24.P3	29
MLFO-24.P4	29
MLFO01	27
MLFO02	28
MLFO03	28
MLFO04	28
MLGM-49D.P1	8
MLGM01	7
MLHOND-31.P1	30
MLHOND-31.P2	30
MLHOND-31.P3	30
MLHOND-31.P4	30
MLHOND-31.P5	31
MLHOND-31.P6	31
MLHOND-31.P7	31
MLHOND-31.P8	31
MLHOND-31.P9	32
MLHOND01	20
MLHOND02	29
MLHOND03	29
MLHU-DH.P4	44
MLHU-HAA.P2	4
MLHU-HAA.P3	76
MLHU-HAA.P4	77
MLHU-HAA.P5	77
MLHU-HAA.P6	77
MLHU-HCA.P1	16 27 37 54
MLHU-HCA.P10	18
MLHU-HCA.P11	18
MLHU-HCA.P2	16 27 38 54
MLHU-HCA.P3	16 54
MLHU-HCA.P4	17 55
MLHU-HCA.P5	17 36 55
MLHU-HCA.P6	17 55

REF	PAG
MLHU-HCA.P7	17 36 56
MLHU-HCA.P8	37 56
MLHU-HCA.P9	16 55
MLHY-11.P5	33
MLHY-11D.P2	33
MLHY-11D.P6	33
MLHY-11D.P7	33
MLHY-18.P2	34
MLHY-18.P4	34
MLHY-18.P5	34
MLHY-18.P6	34
MLHY-18.P7	35
MLHY-18.P8	35
MLHY01	32
MLHY02	32
MLHY03	32
MLISU-3D.P3	35
MLISU-3D.P4	70
MLKI-9.P1	72
MLMAZ-11D.P3	39
MLMAZ-21D.P2	40
MLMAZ-21D.P3	40
MLME-2.P1	41
MLME-2.P2	41
MLME-2.P3	41
MLME-7.P1	42
MLME-7.P2	42
MLME-7.P3	42
MLME-HY.P1	67
MLME-HY.P2	68
MLME01	40
MLME02	40
MLME03	41
MLMIT-12.P3	45
MLMIT-12.P4	45
MLMIT-8D.P3	44
MLMIT-8D.P4	44
MLMIT-8D.P5	45
MLMIT01	43
MLMIT02	44
MLNE-38.P10	61
MLNE-38.P11	49
MLNE-38.P11	61
MLNE-38.P12	49
MLNE-38.P12	61
MLNE-38.P13	62
MLNE-38.P14	62
MLNE-38.P15	57
MLNE-38.P5	18 56
MLNE-38.P6	18 56
MLNE-38.P7	60
MLNE-38.P8	49 60
MLNE-38.P9	61
MLNE-51.P3	57
MLNE-51.P4	57
MLNE-51.P5	57
MLNE-51.P6	58
MLNE-52.P3	37
MLNE-52.P4	64
MLNS01	45
MLOP-11.P3	48







REF	PAG
MLOP-11.P4	48
MLOP-11.P6	8 49
MLOP-11.P7	50
MLOP-11.P8	8
MLOP-WH.P1	8
MLOP-WH.P2	9
MLOP-WH.P3	9
MLOP01	46
MLOP02	47
MLOP03	47
MLOP04	47
MLOP05	47
MLRV01	64
MLSAA-3.P2	64
MLSIX-3.P4	19 58
MLSIX-3.P5	19 58
MLSIX-3.P6	19
MLSIX-3.P7	19 58
MLSIX-3.P8	20
MLSMR-1.P1	68
MLSMR01	67
MLSMR02	67
MLSMR03	67
MLSSA-1.P2	68
MLSUB-2.P1	68
MLSUB-2.P3	69
MLSUB-2.P4	69
MLSUB-3.P3	69
MLSUB-3.P4	69
MLSUZU-14.P3	70
MLSUZU-14.P4	71
MLSUZU01	70
MLSZ01	70
MLTOYO-15.P3	38 72
MLTOYO-15.P4	72
MLTOYO-15.P5	38 73
MLTOYO-15.P6	38 73
MLTOYO-15.P7	73
MLTOYO-15.P9	71
MLTOYO-19.P1	73
MLTOYO-19.P2	39 74
MLTOYO-19.P3	74
MLTOYO-20D.P2	74
MLTOYO-20D.P3	74
MLTOYO-30.P2	39 75
MLTOYO-36.P1	39 75
MLTOYO-43.P1	75
MLTOYO01	37 71
MLTOYO02	71
MLVA-34.P10	63
MLVA-34.P5	62
MLVA-34.P6	62
MLVA-34.P7	63
MLVA-34.P8	20 63
MLVA-34.P9	21 63
MLV001	65 66 75
MLV002	65 66 76
MLV003	65 66 76
MLV004	65 66 76

LLAVES

GILTZAK
KEYS
CLES
SCHLÜSSEL
CHAVES
KLUCZE



THE KEY TO EXCELLENCE
GLOBALLY UNLOCKING MILLIONS OF DOORS DAILY

®	REF. JMA	DETAILS	ORIGINAL
ALFA ROMEO	MLAF01 		
	ALFA ROMEO	MLFI-16.P4 	
ALFA ROMEO		MLFI-16.P5 	
	ALFA ROMEO	MLFI-16.P9 	

CARCASAS

KEY SHELLS





®	REF. JMA	DETAILS	ORIGINAL
AUDI	MLAU01 	  <p>TP00HU-HAA.TLV</p>	
AUDI	MLAU02 	  <p>TP00HU-HAA.TLV</p>	
AUDI	MLAU03 	  <p>TP00HU-HAA.TLV</p>	
AUDI	MLAU04 	  <p>TP00HU-HAA.TLV</p>	

®	REF. JMA	DETAILS	ORIGINAL
AUDI	MLAU05		
AUDI	MLAU06		
AUDI	MLAU07		
AUDI	MLHU-HAA.P2		

HU-HAAC4

CARCASAS

KEY SHELLS

®	REF. JMA	DETAILS	ORIGINAL
BMW	MLBM01	  	
BMW	MLBM02	  	
BMW	MLBM-5.P1	   	
BMW	MLBM-5.P2	   	

®	REF. JMA	DETAILS	ORIGINAL
BMW	MLBM-5.P3  	 	
BMW	MLBM-6.P2  	 	
BMW	MLBM-6.P3  	 	
BMW	MLBM-6.P4  	 	

CARCASAS

KEY SHELLS

®	REF. JMA	DETAILS		ORIGINAL
BMW	MLBM-6.P5 	  <p data-bbox="1098 663 1193 685">BM-6.P5C1</p>		
BMW	MLBM-9.P 	  <p data-bbox="1098 1120 1193 1142">BM-9.P1C1</p>		
CHEVROLET	MLDAE-3D.P6 	 		
CHEVROLET	MLGM01 	  <p data-bbox="1034 1912 1171 1935">TP000P-WHTL2</p>		

®	REF. JMA	DETAILS	ORIGINAL
CHEVROLET	MLGM-49D.P1 	 	
CHEVROLET	MLOP-11.P6 	 	
CHEVROLET	MLOP-11.P8 	 	
CHEVROLET	MLOP-WH.P1 	 	

CARCASAS

KEY SHELLS

®	REF. JMA	DETAILS	ORIGINAL
CHEVROLET	MLOP-WH.P2  	   	
	CHEVROLET	MLOP-WH.P3  	   
CHRYSLER		MLCHR01 	 
	CHRYSLER	MLCHR02 	  

®	REF. JMA	DETAILS	ORIGINAL
CHRYSLER	MLCHR03 	  	
CHRYSLER	MLCHR04 	   	
CHRYSLER	MLCHR05 	  	
CHRYSLER	MLCHR06 	  	

CARCASAS

KEY SHELLS

®	REF. JMA	DETAILS	ORIGINAL
CHRYSLER	MLCHR-15.P2  	  	
CHRYSLER	MLCHR-15.P3  	   	
CHRYSLER	MLCHR-15.P4  	   	
CHRYSLER	MLCHR-15.P5  	   	

®	REF. JMA	DETAILS	ORIGINAL
CHRYSLER	MLCHR-15.P6 	 	
	CITROEN	MLCIT01 	 
CITROEN		MLCIT02 	 
	CITROEN	MLCIT03 	 





CARCASAS

KEY SHELLS

®	REF. JMA	DETAILS	ORIGINAL
CITROEN	MLCIT04 	 	
CITROEN	MLCIT05 	 	
CITROEN	MLCIT-1.P1 	   MLCIT-1.P2	
CITROEN	MLCIT-1.P2 	   PEU-1C1	

Atención: Concerniente a las marcas y denominaciones comerciales ver nota en índice.
 Attention: Concernant les marques et dénominations commerciales voir la note dans l'index.
 Achtung: Bezüglich der Marke und des Handelsnamens achten Sie bitte auf die Hinweise im Index.















Atenção: Relativamente às marcas e denominações comerciais, ver nota no índice.
 Uwaga: W zależności od marki i nazwy handlowej należy zapoznać się z notą w indeksie

®	REF. JMA	DETAILS	ORIGINAL
CITROEN	MLCIT-1.P3 	  PEU-1C1 	
CITROEN	MLCIT-1.P11 	  PEU-1C1 	
CITROEN	MLCIT-1.P4 	  PEU-1C1 	
CITROEN	MLCIT-1.P5 	  PEU-1C1 	

CARCASAS

KEY SHELLS

®	REF. JMA	DETAILS	ORIGINAL
CITROEN	MLCIT-1.P6 	  PEU-1C1 	
CITROEN	MLCIT-1.P7 	  PEU-1C1 	
CITROEN	MLCIT-1.P10 	  PEU-1C1 	
CITROEN	MLCIT-1.P14 	  PEU-1C1 	

®	REF. JMA	DETAILS	ORIGINAL
CITROEN	<p>MLHU-HCA.P1</p>  	   <p>MLHU-HCA.P2</p>	
CITROEN	<p>MLHU-HCA.P2</p>  	 	
CITROEN	<p>MLHU-HCA.P3</p>  	 	
CITROEN	<p>MLHU-HCA.P9</p>  	 	

CARCASAS

KEY SHELLS

®	REF. JMA	DETAILS	ORIGINAL
CITROEN	MLHU-HCA.P4 	 	
CITROEN	MLHU-HCA.P5 	 	
CITROEN	MLHU-HCA.P6 	 	
CITROEN	MLHU-HCA.P7 	 	

®	REF. JMA	DETAILS	ORIGINAL
CITROEN	MLHU-HCA.P10 	 	
CITROEN	MLHU-HCA.P11 	 	
CITROEN	MLNE-38.P5 	 	
CITROEN	MLNE-38.P6 	 	

MLNE-38.P6

NE-60C3

CARCASAS

KEY SHELLS











®	REF. JMA	DETAILS	ORIGINAL
CITROEN	MLSIX-3.P4  	   <p>MLSIX-3.P5</p>	
CITROEN	MLSIX-3.P5  	 	
CITROEN	MLSIX-3.P6  	 	
CITROEN	MLSIX-3.P7  	 	

®	REF. JMA	DETAILS	ORIGINAL
CITROEN	<p>MLSIX-3.P8</p>  	 	
COBRA	<p>MLHOND01</p> 	 	
DACIA	<p>MLDAC-4D.P1</p>  	 	<p>DAC-4DC1</p>  
DACIA	<p>MLVA-34.P8</p>  	 	<p>VA-61C3</p>  

CARCASAS

KEY SHELLS

®	REF. JMA	DETAILS		ORIGINAL
DACIA	MLVA-34.P9 	 		
	 <p>VA-61C3</p>			
FIAT	MLFI01 		 	
FIAT	MLFI02 			
FIAT	MLFI03 			

®	REF. JMA	DETAILS		ORIGINAL
FIAT	MLFI04			
FIAT	MLFI05			
FIAT	MLFI06			
FIAT	MLFI07			

CARCASAS

KEY SHELLS

®	REF. JMA	DETAILS	ORIGINAL
FIAT	MLFI08		
FIAT	MLFI09		
FIAT	MLFI10		
FIAT	MLFI11		

®	REF. JMA	DETAILS	ORIGINAL
FIAT	MLFI12		
FIAT	MLFI-13.P9		
FIAT	MLFI-13.P10		
FIAT	MLFI-16.P2		

CARCASAS

KEY SHELLS

®	REF. JMA	DETAILS	ORIGINAL
FIAT	MLFI-16.P3 	 	
FIAT	MLFI-16.P6 	 	
FIAT	MLFI-16.P7 	 	
FIAT	MLFI-16.P8 	 	

®	REF. JMA	DETAILS	ORIGINAL
FIAT	MLFI-16.P10 	  FI-16.P10C3	
FIAT	MLFI-16.P11 	 	
FIAT	MLFI-16.P12 	 	
FIAT	MLFI-16.P13 	 	

CARCASAS

KEY SHELLS













®	REF. JMA	DETAILS	ORIGINAL
FIAT	MLFI-16.P14 	  	
FIAT	MLHU-HCA.P1 	    <p>MLHU-HCA.P2</p>	
FIAT	MLHU-HCA.P2 	  	
FORD	MLF001 	    <p>TP00FO-6.TL TP00FO-24.TL</p>	

®	REF. JMA	DETAILS	ORIGINAL
FORD	MLF002 	  TP00FO-6.TL2 TP00FO-24.TL2	
FORD	MLF003 	 	
FORD	MLF004 	  TP00FO-6.TL TP00FO-24.TL	
FORD	MLFO-24.P1 	 	

CARCASAS





















KEY SHELLS

®	REF. JMA	DETAILS	ORIGINAL
FORD	<p>MLFO-24.P3</p> 	 <p>FO-24.P3C10</p>	
FORD	<p>MLFO-24.P4</p> 		
HONDA	<p>MLHOND02</p> 		
HONDA	<p>MLHOND03</p> 		

®	REF. JMA	DETAILS	ORIGINAL
HONDA	MLHOND-31.P1	 	
HONDA	MLHOND-31.P2	 	
HONDA	MLHOND-31.P3	 	
HONDA	MLHOND-31.P4	 	

CARCASAS

KEY SHELLS

















®	REF. JMA	DETAILS	ORIGINAL
HONDA	MLHOND-31.P5  	  <p>CHIP</p>	
HONDA	MLHOND-31.P6  	 	
HONDA	MLHOND-31.P7  	 	
HONDA	MLHOND-31.P8  	 	

®	REF. JMA	DETAILS	ORIGINAL
HONDA	MLHOND-31.P9 	 	
HYUNDAI	MLHY01 	 	
HYUNDAI	MLHY02 	 	
HYUNDAI	MLHY03 	 	

CARCASAS

KEY SHELLS

®	REF. JMA	DETAILS	ORIGINAL
HYUNDAI	MLHY-11.P5  	 	
HYUNDAI	MLHY-11D.P2  	 	
HYUNDAI	MLHY-11D.P6  	 	
HYUNDAI	MLHY-11D.P7  	 	

®	REF. JMA	DETAILS	ORIGINAL
HYUNDAI	MLHY-18.P2  	 	
	HYUNDAI	MLHY-18.P4  	 
HYUNDAI		MLHY-18.P5  	 
	HYUNDAI	MLHY-18.P6  	 

HY-18.P4C2



HY-18.P4C2



HY-18.P4C2



CARCASAS

KEY SHELLS

®	REF. JMA	DETAILS	ORIGINAL
HYUNDAI	MLHY-18.P7  	 	
HYUNDAI	MLHY-18.P8  	 	
ISUZU	MLISU-3D.P3  	 	
IVECO	MLFI-13.P11  	 	

HY-18.P4C2

®	REF. JMA	DETAILS	ORIGINAL
LANCIA	MLFI-13.P10  	 	
LANCIA	MLFI-16.P3  	 	
LANCIA	MLHU-HCA.P5  	 	
LANCIA	MLHU-HCA.P7  	 	

CARCASAS



KEY SHELLS

®	REF. JMA	DETAILS	ORIGINAL
LANCIA	MLHU-HCA.P8  	 	
LAND RANGE ROVER	MLNE-52.P3  	 	
LEXUS	MLTOY001  	 	
LEXUS	MLHU-HCA.P1  	   <p data-bbox="1034 1877 1152 1908">MLHU-HCA.P2</p>	

®	REF. JMA	DETAILS	ORIGINAL
LEXUS	MLHU-HCA.P2  	 	
LEXUS	MLTOYO-15.P3  	 	
LEXUS	MLTOYO-15.P5  	 	
LEXUS	MLTOYO-15.P6  	 	

CARCASAS

KEY SHELLS

®	REF. JMA	DETAILS	ORIGINAL
LEXUS	MLTOYO-19.P2  	 	
LEXUS	MLTOYO-30.P2  	 	
LEXUS	MLTOYO-36.P1  	 	
MAZDA	MLMAZ-11D.P3  	 	

®	REF. JMA	DETAILS	ORIGINAL
MAZDA	MLMAZ-21D.P2 	 	
MAZDA	MLMAZ-21D.P3 	 	
MERCEDES	MLME01 	 	
MERCEDES	MLME02 	 	

CARCASAS

KEY SHELLS

®	REF. JMA	DETAILS	ORIGINAL
MERCEDES	<p>MLME03</p> 	 	
MERCEDES	<p>MLME-2.P1</p>  	 	
MERCEDES	<p>MLME-2.P2</p>  	 	
MERCEDES	<p>MLME-2.P3</p>  	 	

®	REF. JMA	DETAILS	ORIGINAL
MERCEDES	MLME-7.P1 	 	
	MERCEDES	MLME-7.P2 	 
MERCEDES		MLME-7.P3 	 
	MINI	MLBM-8.P1 	 

CARCASAS

KEY SHELLS

®	REF. JMA	DETAILS	ORIGINAL
MINI	MLBM-8.P2 	 	
MINI	MLBM-8.P3 	 	
MINI	MLBM-8.P4 	 	
MITSUBISHI	MLMIT01 	 	

®	REF. JMA	DETAILS	ORIGINAL
MITSUBISHI	MLMIT02	 	
			
MITSUBISHI	MLHU-DH.P4	 	
			
MITSUBISHI	MLMIT-8D.P3	 	
			
MITSUBISHI	MLMIT-8D.P4	 	
			

CARCASAS

KEY SHELLS

®	REF. JMA	DETAILS	ORIGINAL
MITSUBISHI	<p>MLMIT-8D.P5</p>  	  	
MITSUBISHI	<p>MLMIT-12.P3</p>  	  	
MITSUBISHI	<p>MLMIT-12.P4</p>  	   	
NISSAN	<p>MLNS01</p> 	  	

	REF. JMA	DETAILS	ORIGINAL
NISSAN	MLDAT-15.P6	 	
	MLDAT-15.P7	 	
	MLDAT-15.P8	 	
	MLOP01	 	

TP000P-11.TL
 TP000P-D.TL
 TP000P-S.TL
 TP000P-WH.TL

CARCASAS

KEY SHELLS

®	REF. JMA	DETAILS	ORIGINAL
OPEL	<p>MLOP02</p> 	  <p>TP000P-11.TL TP000P-D.TL TP000P-S.TL TP000P-WH.TL</p>	
OPEL	<p>MLOP03</p> 	  <p>TP000P-11.TL2 TP000P-D.TL2 TP000P-S.TL2</p>	
OPEL	<p>MLOP04</p> 	 	
OPEL	<p>MLOP05</p> 	 	

®	REF. JMA	DETAILS	ORIGINAL
OPEL	<p>MLOP-11.P3</p>  	  	
OPEL	<p>MLOP-11.P4</p>  	   	
OPEL	<p>MLCIT-1.P8</p>  	  	
OPEL	<p>MLCIT-1.P9</p>  	   	

CARCASAS

KEY SHELLS

















®	REF. JMA	DETAILS	ORIGINAL
OPEL	<p>MLNE-38.P8</p>  	    <p>NE-60C3</p>	
OPEL	<p>MLNE-38.P11</p>  	    <p>NE-60C3</p>	
OPEL	<p>MLNE-38.P12</p>  	     <p>NE-60C3</p>	
OPEL	<p>MLOP-11.P6</p>  	    <p>NE-60C3</p>	

®	REF. JMA	DETAILS	ORIGINAL
OPEL	MLOP-11.P7 	 	
PEUGEOT	MLCIT01 	 	
PEUGEOT	MLCIT02 	 	
PEUGEOT	MLCIT03 	 	

CARCASAS

KEY SHELLS

®	REF. JMA	DETAILS	ORIGINAL
PEUGEOT	<p>MLCIT04</p> 	 	
PEUGEOT	<p>MLCIT-1.P1</p>  	   <p>MLCIT-1.P2</p>	
PEUGEOT	<p>MLCIT-1.P2</p>  	   <p>PEU-1C1</p>	
PEUGEOT	<p>MLCIT-1.P3</p>  	   <p>PEU-1C1</p>	

®	REF. JMA	DETAILS	ORIGINAL
PEUGEOT	MLCIT-1.P11 	 PEU-1C1 	
PEUGEOT	MLCIT-1.P4 	 PEU-1C1 	
PEUGEOT	MLCIT-1.P5 	 PEU-1C1 	
PEUGEOT	MLCIT-1.P6 	 PEU-1C1 	

CARCASAS

KEY SHELLS























®	REF. JMA	DETAILS	ORIGINAL
PEUGEOT	<p>MLCIT-1.P7</p>  	 <p>PEU-1C1</p> 	
PEUGEOT	<p>MLCIT-1.P10</p>  	 <p>PEU-1C1</p> 	
PEUGEOT	<p>MLFI01</p>  	 	
PEUGEOT	<p>MLFI02</p>  		

®	REF. JMA	DETAILS	ORIGINAL
PEUGEOT	<p>MLFI-16.P7</p>  	 	
PEUGEOT	<p>MLHU-HCA.P1</p>  	   <p>MLHU-HCA.P2</p>	
PEUGEOT	<p>MLHU-HCA.P2</p>  	 	
PEUGEOT	<p>MLHU-HCA.P3</p>  	 	













CARCASAS

KEY SHELLS

®	REF. JMA	DETAILS	ORIGINAL
PEUGEOT	MLHU-HCA.P9 	 	
PEUGEOT	MLHU-HCA.P4 	 	
PEUGEOT	MLHU-HCA.P5 	 	
PEUGEOT	MLHU-HCA.P6 	 	

®	REF. JMA	DETAILS	ORIGINAL
PEUGEOT	MLHU-HCA.P7  	 	
PEUGEOT	MLHU-HCA.P8  	 	
PEUGEOT	MLNE-38.P5  	   <p data-bbox="1034 1413 1134 1440">MLNE-38.P6</p>  <p data-bbox="1102 1574 1182 1601">NE-60C3</p>	
PEUGEOT	MLNE-38.P6  	 	













CARCASAS KEY SHELLS

®	REF. JMA	DETAILS	ORIGINAL
PEUGEOT	<p>MLNE-38.P15</p>  		
PEUGEOT	<p>MLNE-51.P3</p>  	 <p>MLNE-51.P4</p>	
PEUGEOT	<p>MLNE-51.P4</p>  	 <p>PEU-2C1</p>	
PEUGEOT	<p>MLNE-51.P5</p>  	 <p>PEU-2C1</p>	

®	REF. JMA	DETAILS		ORIGINAL
PEUGEOT	<p>MLNE-51.P6</p>  	    		
	PEUGEOT	<p>MLSIX-3.P4</p>  	   	
PEUGEOT		<p>MLSIX-3.P5</p>  	  	
	PEUGEOT	<p>MLSIX-3.P7</p>  	  	

CARCASAS



















KEY SHELLS

®	REF. JMA	DETAILS	ORIGINAL
RENAULT	<p>MLCIT-1.P1</p> 	 <p>MLCIT-1.P2</p>	
RENAULT	<p>MLCIT-1.P2</p> 	 <p>PEU-1C1</p>	
RENAULT	<p>MLCIT-1.P8</p> 		
RENAULT	<p>MLCIT-1.P9</p> 		

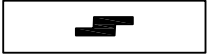
®	REF. JMA	DETAILS		ORIGINAL	
RENAULT	MLCIT-1.P12 	 			
	PEU-1C1 	RENAULT	MLCIT-1.P13 	  	
PEU-1C1 	RENAULT		MLNE-38.P7 	 	
NE-60C3 		RENAULT	MLNE-38.P8 	 	
NE-60C3 					

CARCASAS





















KEY SHELLS

®	REF. JMA	DETAILS	ORIGINAL
RENAULT	MLNE-38.P9 	  NE-60C3 	
RENAULT	MLNE-38.P10 	  NE-60C3 	
RENAULT	MLNE-38.P11 	  NE-60C3 	
RENAULT	MLNE-38.P12 	  NE-60C3 	

®	REF. JMA	DETAILS		ORIGINAL
RENAULT	MLNE-38.P13			
RENAULT	MLNE-38.P14			
RENAULT	MLVA-34.P5			
RENAULT	MLVA-34.P6			

CARCASAS

KEY SHELLS

®	REF. JMA	DETAILS		ORIGINAL
RENAULT	MLVA-34.P7 	 		
RENAULT	MLVA-34.P8 	 		
RENAULT	MLVA-34.P9 	 		
RENAULT	MLVA-34.P10 	  		

®	REF. JMA	DETAILS		ORIGINAL
ROVER	MLRV01		<div data-bbox="762 324 925 398">  </div> 	
	ROVER	MLBM-8.P3	 	<div data-bbox="762 772 925 846">  </div> 
ROVER		MLNE-52.P4	 	<div data-bbox="762 1220 925 1294">  </div> 
	SAAB	MLSAA-3.P2	 	<div data-bbox="762 1668 1013 1742">  </div> 

SAA-3.P2C2



CARCASAS

KEY SHELLS

®	REF. JMA	DETAILS	ORIGINAL
SEAT	MLV001	  <p data-bbox="1034 544 1185 566">TP00HU-HAA.TLN</p>	
SEAT	MLV002	  <p data-bbox="1034 987 1185 1010">TP00HU-HAA.TLN</p>	
SEAT	MLV003	 	
SEAT	MLV004	 	

®	REF. JMA	DETAILS	ORIGINAL
SKODA	MLV001	  <p data-bbox="1031 539 1187 566">TP00HU-HAA.TLN</p>	
SKODA	MLV002	  <p data-bbox="1031 996 1187 1023">TP00HU-HAA.TLN</p>	
SKODA	MLV003	 	
SKODA	MLV004	 	

CARCASAS





















KEY SHELLS

®	REF. JMA	DETAILS		ORIGINAL
SMART	<p>MLSMR01</p> 			
SMART	<p>MLSMR02</p> 			
SMART	<p>MLSMR03</p> 			
SMART	<p>MLME-HY.P1</p> 			

®	REF. JMA	DETAILS	ORIGINAL
SMART	MLME-HY.P2  	 	
SMART	MLSMR-1.P1  	 	
SSANGYONG	MLSSA-1.P2  	 	
SUBARU	MLSUB-2.P1  	 	

CARCASAS

KEY SHELLS

®	REF. JMA	DETAILS	ORIGINAL
SUBARU	MLSUB-2.P3  	 	
SUBARU	MLSUB-2.P4  	 	
SUBARU	MLSUB-3.P3  	 	
SUBARU	MLSUB-3.P4  	 	

®	REF. JMA	DETAILS	ORIGINAL
SUBARU	MLISU-3D.P4      		
SUZUKI	MLSUZU01    		
SUZUKI	MLSZ01   		
SUZUKI	MLSUZU-14.P3     		

CARCASAS

KEY SHELLS

®	REF. JMA	DETAILS		ORIGINAL
SUZUKI	<p>MLSUZU-14.P4</p>  	 		
	<p>SUZU-14.P4C1</p> 			
SUZUKI	<p>MLTOYO-15.P9</p>  	 		
TOYOTA	<p>MLTOY001</p> 	 		
TOYOTA	<p>MLTOY002</p> 	 		

®	REF. JMA	DETAILS	ORIGINAL
TOYOTA	MLKI-9.P1    		
TOYOTA	MLCIT-1.P15     	 	
TOYOTA	MLTOYO-15.P3    		
TOYOTA	MLTOYO-15.P4     		

CARCASAS

KEY SHELLS

®	REF. JMA	DETAILS	ORIGINAL
TOYOTA	MLTOYO-15.P5  		
TOYOTA	MLTOYO-15.P6  		
TOYOTA	MLTOYO-15.P7  		
TOYOTA	MLTOYO-19.P1  		

®	REF. JMA	DETAILS	ORIGINAL
TOYOTA	MLTOYO-19.P2		
TOYOTA	MLTOYO-19.P3		
TOYOTA	MLTOYO-20D.P2		
TOYOTA	MLTOYO-20D.P3		

CARCASAS

KEY SHELLS

®	REF. JMA	DETAILS	ORIGINAL
TOYOTA	MLTOYO-30.P2  	 	
TOYOTA	MLTOYO-36.P1  	 	
TOYOTA	MLTOYO-43.P1  	 	
VOLKSWAGEN	MLV001  	 	

TP00HU-HAA.TLN

®	REF. JMA	DETAILS	ORIGINAL
VOLKSWAGEN	MLV002	  <p data-bbox="1034 539 1185 562">TP00HU-HAA.TLN</p>	
VOLKSWAGEN	MLV003	 	
VOLKSWAGEN	MLV004	 	
VOLKSWAGEN	MLHU-HAA.P3	 	

CARCASAS

KEY SHELLS

®	REF. JMA	DETAILS	ORIGINAL
VOLKSWAGEN	MLHU-HAA.P4 	  HU-HAAC1 	
VOLKSWAGEN	MLHU-HAA.P5 	  HU-HAAC1 	
VOLKSWAGEN	MLHU-HAA.P6 	  HU-HAAC1 	

OTROS

BESTE BATZUK
OTHERS
AUTRES
ANDERE
OUTRAS
INNE



THE KEY TO EXCELLENCE
GLOBALLY UNLOCKING MILLIONS OF DOORS DAILY

DACIA

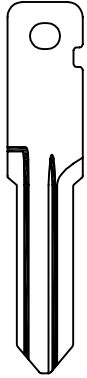

DAC-4DC1

FORD

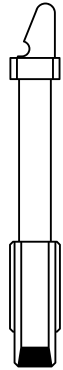

FO-6C1

ALP.

HUF

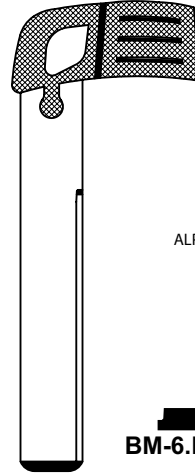

BM-6.P5C1

ALP.

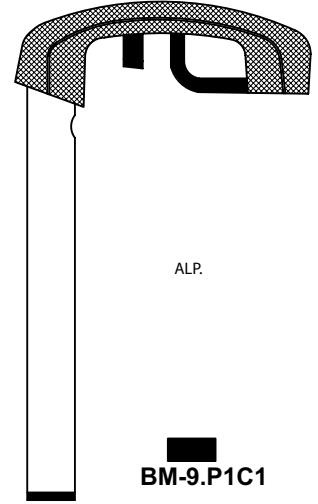

BM-9.P1C1

ALP.

HUF

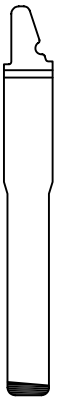

FO-24C2

ALP.

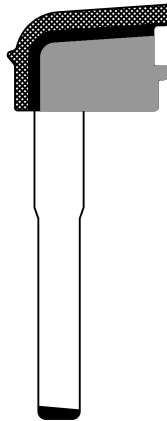

FO-24.P3C10

ALP.



HU-HAAC1

ALP.



HU-HCAC1

ALP.

HUF



HU-HCAC3

LAT.

HYUNDAI

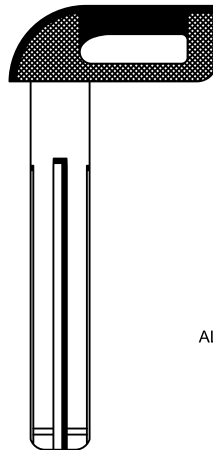

HY-18.P4C2

ALP.

NEIMAN

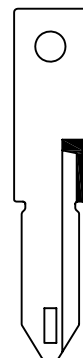

NE-60C1

ESPADINES

BLADES

NEIMAN

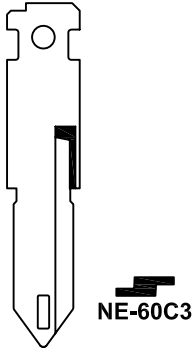

SAAB

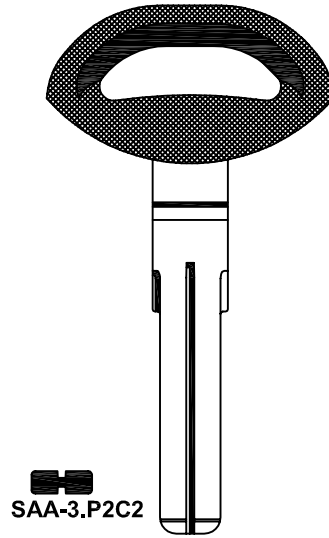

SUZUKI

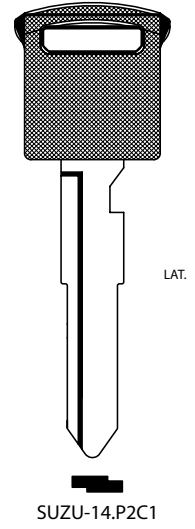

TRW- SIPEA

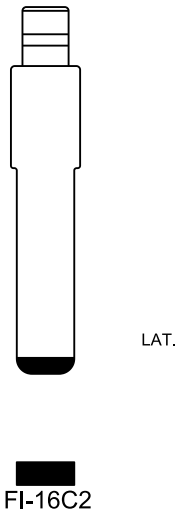
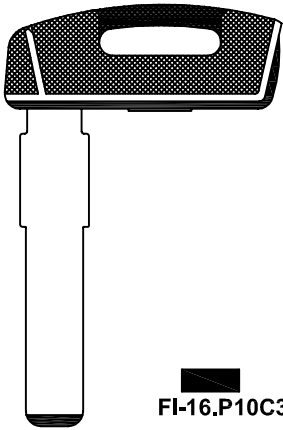

VACHETTE

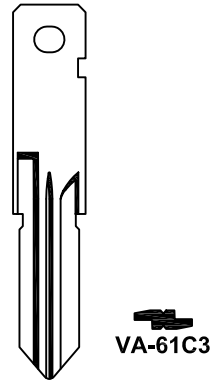

VALEO

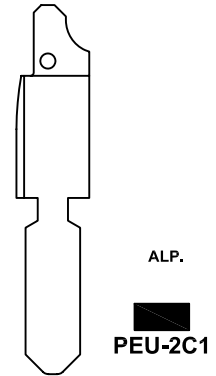

VALEO

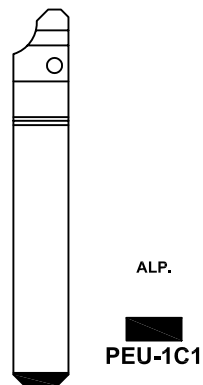
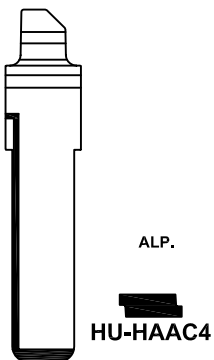

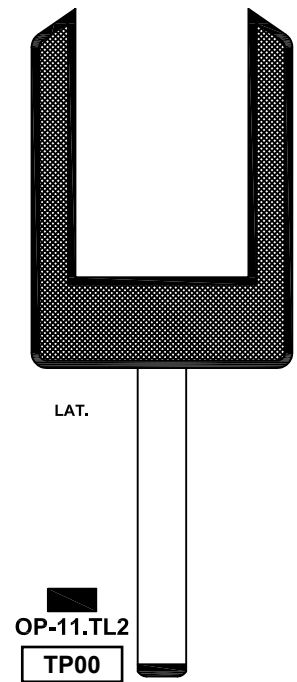
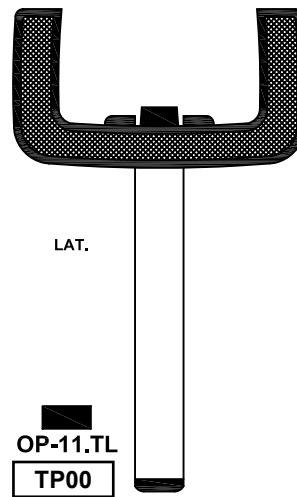
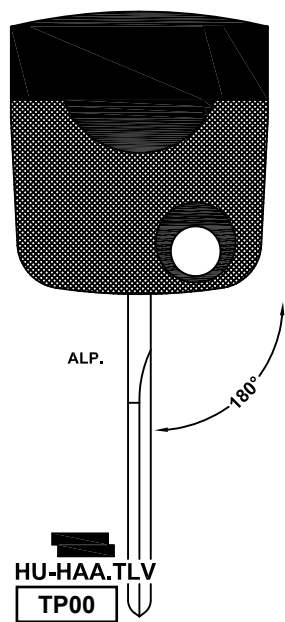
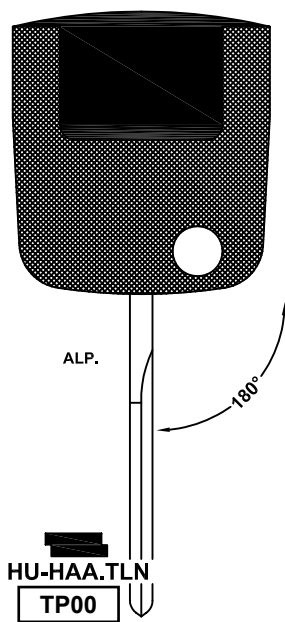
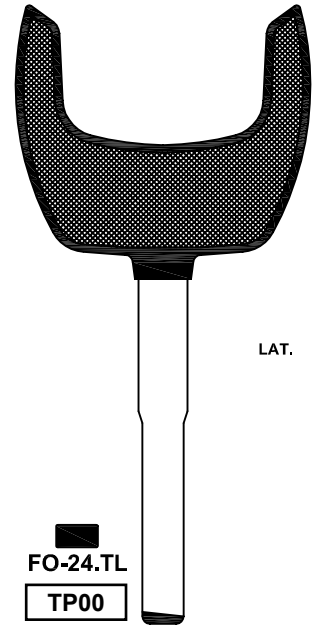
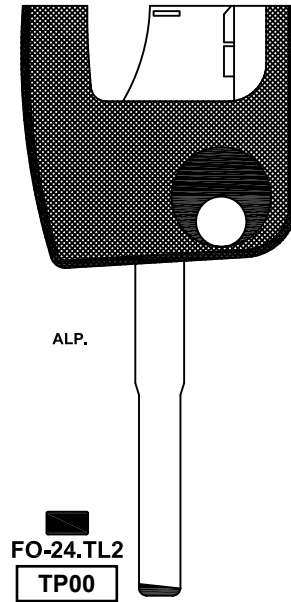
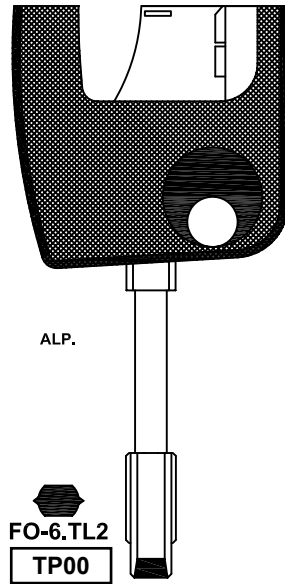
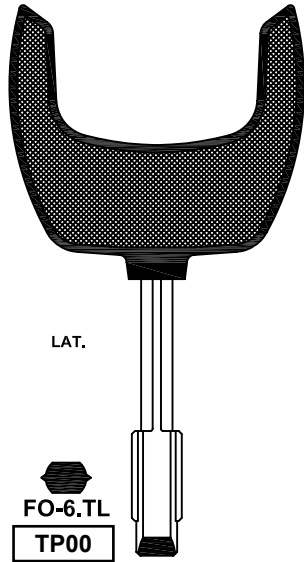

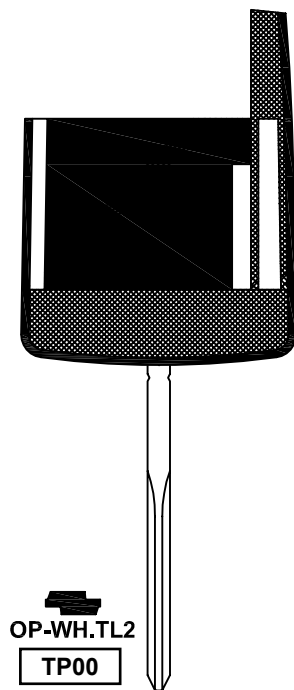
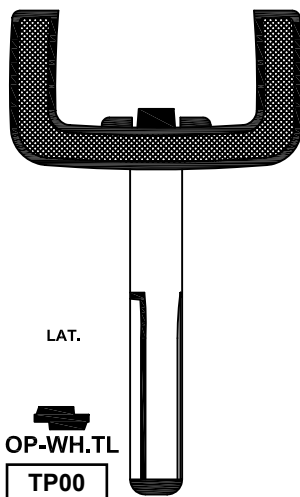
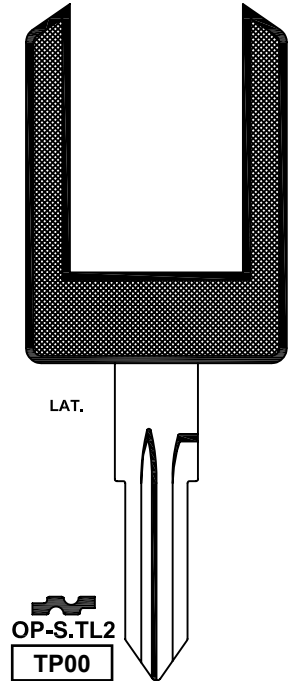
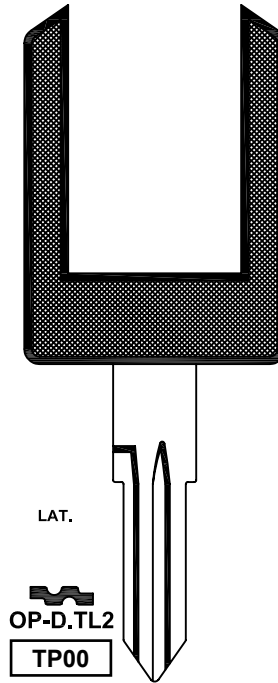
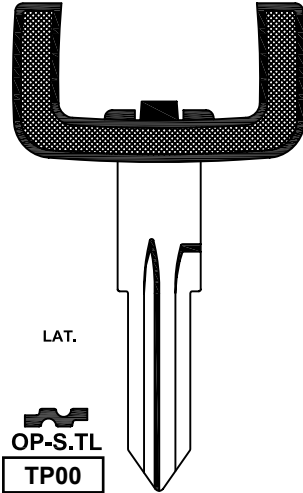
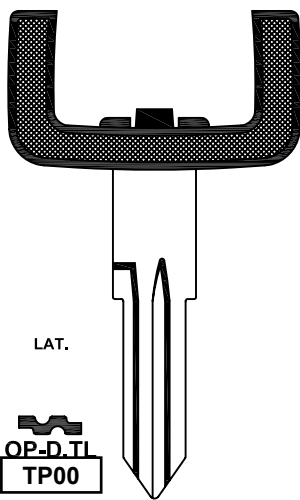

SWITCH BLADE**SWITCH BLADE**

**Soporte para cambio de espadines de las llaves escamoteables.
160 x 100 x 30 mm (ancho x largo x altura)**

*Support jig to enable easy and safe changing of blade of flipkey keys.
160 x 100 x 30 mm (width x length x height)*

**KIT PUNZONES**

KIT Punzones para Switch Blade.

*PUNCH KIT
Punch KIT for Switch Blade.*

JMA FRANCE

JMA FRANCE SAS
Tel +33 01 39 22 42 10
Fax +33 01 39 22 42 11
Technoparc
13, rue Edouard Jeanneret
F- 78306 Poissy Cedex
www.jmafrance.fr
service.commercial@jmafrance.fr

JMA POLSKA

JMA POLSKA Sp. z o.o.
Tel +48 42 635 12 80
Fax +48 42 651 54 63
91- 342 Łódź, ul. Zbąszyńska 3
www.jmapolska.pl
biuro@jmapolska.pl

JMA PORTUGAL

ALTUNA PORTUGAL
COMERCIO DE CHAVES UNIPessoal, LDA.
Tel +351 219 947 470
Fax +351 219 947 471
Rua de Goa N°22
2690-356 Santa Iria de Azoia
www.jmaportugal.com
comercial@jmaportugal.com

JMA UK

SKS LTD
Tel +44 144 229 1400
Fax +44 144 286 3683
Unit 2, Canalside Northbridge Road
Berkhamsted
Herts HP4 1EG
www.jmakeys.co.uk
sales@skskeys.co.uk

JMA MAROC

JMA MAROC S.A.R.L.
Tel +0520 150 535
Fax +0520 150 536
83,85 Bd Oued ZIZ, El Oulfa
Casablanca
www.jma.ma
jma@jma.ma

JMA INDIA

JMA KEYS INDIA PVT. LTD
Tel +91 124 428 5450
Fax +91 124 428 5451
H-239 & H-240, Sushant Shopping Arcade
Sushant Lok-1, Block B
122002 Gurgaon (Haryana)
www.jmakeys.in
info@jmakeys.in

JMA MEXICO

LLAVES ALTUNA DE MEXICO S.A de C.V
Tel +52 33 3777 1600
Fax +52 33 3777 1609
Av. Aviación No. 5520
Col. San Juan de Ocotán
C.P. 45019 Zapopan, Jalisco
www.jma.com.mx
ventas@jma.com.mx

JMA PERU

JMA PERU S.A.C.
Tel +51 639 9300
Av. Los Paracas 130,
Urbanización Salamanca,
Distrito Ate, Lima
www.jma-peru.com
info@jma-peru.com

JMA COLOMBIA

IFAM - JMA Colombia, S.A.S.
Tel +57 1 53333246
Fax +57 3203497446
Diagonal 115A - 70B - 45 Local 1
Bogotá
www.jmacolombia.com
info@jmacolombia.com

JMA SPAIN

JMA ALEJANDRO ALTUNA, S.L.U.
Tel +34 943 79 30 00
Fax +34 943 79 72 43
Bidekurtzeta, 6 P.O.Box - Apdo. 70
20500 Arrasate - Mondragón
Gipuzkoa – SPAIN
www.jma.es
jma@jma.es

JMA USA

ALTUNA GROUP USA INC.
Tel +1 817 385 0515
Fax +1 817 385 4850
1513 Greenview Drive
75050 Grand Prairie
Texas
www.jmausa.com
info@jmausa.com

JMA ARGENTINA

JMA ARGENTINA S.A.
Tel +54 336 4 462 422
Fax +54 336 4 462 422
Av. Central Acero Argentino Oeste 678
COMIRSA - 2900 San Nicolas
www.jma.com.ar
info@jma.com.ar

JMA URUGUAY

JMA URUGUAY S.A.
Tel +598 2908 1175
Fax +598 2900 6681
Mercedes 1420
11100 Montevideo
www.jma.com.uy
info@jma.com.uy

JMA WORLDWIDE

ALTUNA GROUP HEADQUARTERS

Tel +34 943 79 30 00
Fax +34 943 79 72 43
Bidekurtzeta, 6 P.O.Box - Apdo. 70
20500 Arrasate - Mondragón
Gipuzkoa – SPAIN
www.altuna.com

